

Electrobar Elite®

ELECTROMOTIVE SYSTEMS

a  **Magnetek Company**

Electromotive Systems

proudly offers the next generation of overhead crane conductor bar systems, Electrobar Elite®.

This innovative conductor bar system is designed to reduce costly installation time and improve safety, while being easy to service and maintain.

Reduces Installation Time and Cost

The Electrobar Elite conductor bar system has many design features that significantly reduce installation time when compared to traditional eight bar systems. The line elements are easily connected to each other by means of snap away bolts, which prevent over-torquing of the line element connection points. The line elements are easily attached to a snap-in hanger, which mounts with one bolt to the hanger bracket. Joint covers and power feed assemblies simply snap together over the line elements to complete the system. Minimal assembly tools are required, making installation a breeze, saving you time and money.

Improves Safety

In addition to ease of installation, Electrobar Elite significantly reduces potential electrical shock hazards that exist with conventional conductor bar systems. The unique conductor bar system includes enclosed copper conductors that meet the finger safe rating of IP23. Also, the four conductor collector assembly can only be installed in one orientation to the line element, insuring the ground conductor and the ground collector brush are always together.

Simple to Service and Maintain

System maintenance is minimal with the collector brushes being the only item that may need replacement during periodic service intervals. The inexpensive collector brushes simply snap into and out of the collector assemblies, minimizing time spent on service and maximizing productivity of your crane system.

You'll be pleased to know Electrobar Elite offers the following options:

Inlet Gates - which allow for installation or removal of collector trolleys for maintenance.

Curved line elements - available from 28" minimum radius.

Line element covers - prevent contamination build-up on copper conductors.

High speed collector assemblies - for travel speeds exceeding 325ft/min.

Ventilated line elements - prevent condensation build-up on system.

High temperature line elements - available for 55°C to 75°C ambient operating environments.

Five conductor systems - available through 200 amp on a special order basis. Please consult factory for additional information.

If you're looking for a conductor bar system that reduces installation time and total system cost, maximizes safety and is simple to service, then you want Electrobar Elite!

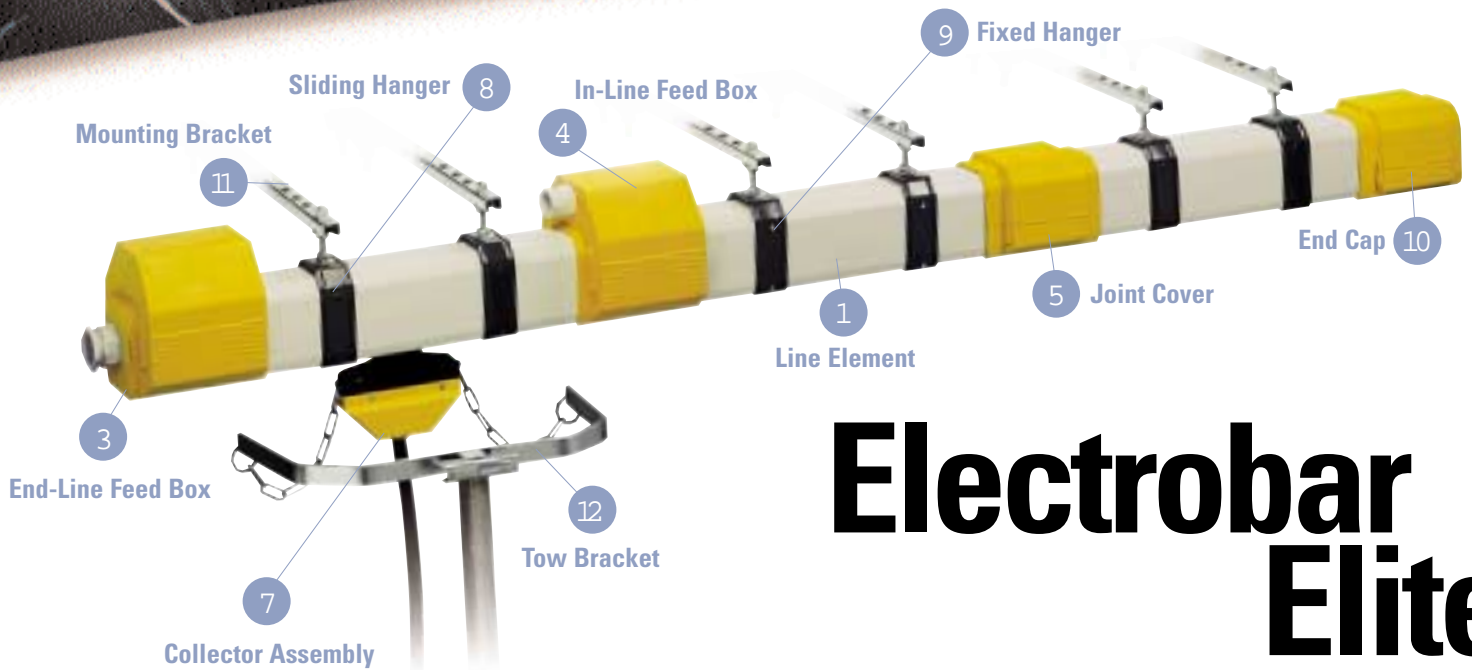

Electrobar Elite®



1. Line Element

FOUR (4) CONDUCTOR LINE ELEMENTS AVAILABLE IN 60 AMP, 100 AMP, 130 AMP AND 200 AMP RATINGS.

Self-extinguishing PVC construction with copper conductors
 Standard lengths 1, 2 and 4 meters
 Special lengths available - consult factory
 Maximum rated operational voltage 750 volts

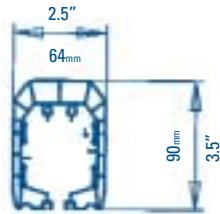

| | Part Numbers | | | |
|-----------------------------|--------------|---------|---------|--------|
| | 60 Amp | 100 Amp | 130 Amp | 200Amp |
| 4 Meter (13.123 ft.) | 5000 | 5001 | 5002 | 5003 |
| 2 Meter (6.562 ft.) | 5004 | 5005 | 5006 | 5007 |
| 1 Meter (3.281 ft.) | 5008 | 5009 | 5010 | 5011 |
| Weight lb/ft | 1.2 | 1.34 | 1.62 | 2.5 |



3. End-Line Power Feed

60 and 100 Amp

FEEDS POWER TO SYSTEM FROM END OF A LINE ELEMENT RUN. DESIGN ALLOWS FOR QUICK POWER CONNECTION WITH A SNAP TOGETHER COVER.

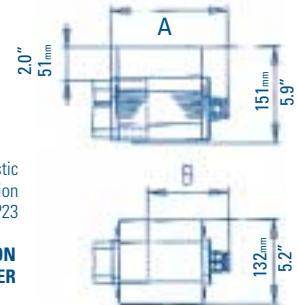

Thermoplastic
 Self-extinguishing construction
 Rated IP23

POWER FEED SELECTION BASED ON POWER FEED CORD DIAMETER

| Part No. | Cable Diameter in / mm | Dimension "A" in / mm | Dimension "B" in / mm | Weight lbs. |
|-----------|------------------------|-----------------------|-----------------------|-------------|
| 5015/PG21 | .41-.71 / 12-18 | 7.125 / 181 | 4.96 / 126 | 0.9 |
| 5016/PG29 | .63-.94 / 13-24 | 7.250 / 183 | 5.04 / 128 | 0.9 |



2. Expansion Line Element

EXPANSIONS ARE NEEDED IN 60 AMP AND 100 AMP SYSTEMS FOR APPLICATIONS LONGER THAN 494 FEET (150 METERS)

EXPANSIONS ARE NEEDED IN 130 AMP AND 200 AMP SYSTEMS FOR APPLICATIONS LONGER THAN 820 FEET (250 METERS)

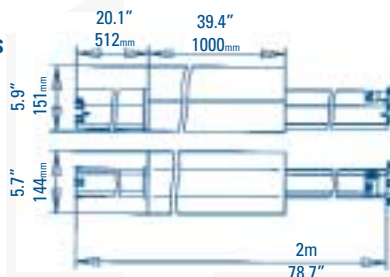

| | Part Numbers | | | |
|------------------|--------------|---------|---------|-----------------|
| | 60 Amp | 100 Amp | 130 Amp | 200 Amp |
| Expansion | 5012 | 5013 | 5014 | Consult Factory |

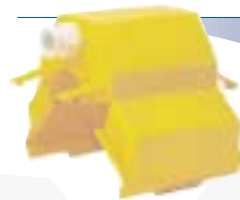

4. In-Line Feed-Box

60 and 100 Amp

DESIGNED TO FEED POWER TO THE SYSTEM ALONG LINE ELEMENT RUN. ALLOWS FOR QUICK POWER CONNECTION WITH SNAP TOGETHER COVER.

Thermoplastic
 Self-extinguishing construction
 Rated IP23

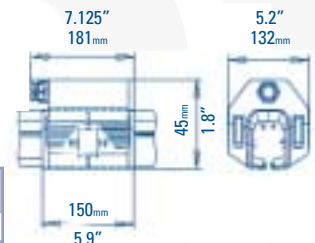

| Part No. | Cable Diameter in/mm | Weight lbs |
|-----------|----------------------|------------|
| 5017/PG21 | .41-.71 / 12-18 | 0.9 |

Standard Features & Benefits

- Snap together covers, power feeds and hangers
- Lightweight, rigid construction
- Ease of installation, lower total system cost
- Low maintenance
- Improved safety, (finger safe rating of IP23)

4. In-Line Feed with Junction Box

60 and 100 Amp



DESIGNED TO FEED POWER TO THE SYSTEM ALONG LINE ELEMENT RUN AND INCLUDES A JUNCTION BOX FOR TERMINAL CONNECTIONS

PART NO.
5046

Thermoplastic
Self-extinguishing construction
Rated IP23

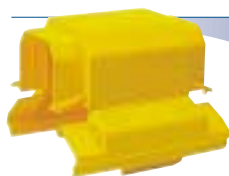
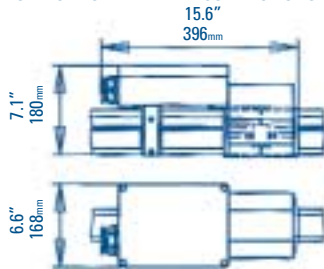

5. Joint Cover

60, 100, 130 and 200 Amp

SELF CENTERING SNAP-ON JOINT COVER

PART NO.
5018

Thermoplastic
Self-extinguishing construction
Rated IP23

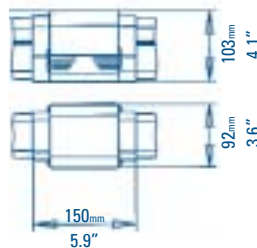

7. Four (4) Conductor Collector Assembly

Single Collector - 40 Amp Rating

Double Collector - 80 Amp Rating

Triple Collector - 120 Amp Rating

- Collector selection based on amperage requirements
- The collector assembly can be installed only in one orientation to the line element, insuring the ground conductor and the ground collector brush are always together.
- The brushes snap into the collector assembly which provide quick and easy replacement
- Collectors are provided with one (1) meter of cable as standard

| Part No. | Type | Amp Rating | Weights lbs |
|----------|--------|------------|-------------|
| 5021 | Single | 40 Amp | 1.80 |
| 5023 | Double | 80 Amp | 3.10 |
| 5025 | Triple | 120 Amp | 4.50 |

Single Collector - 40 Amp Rating

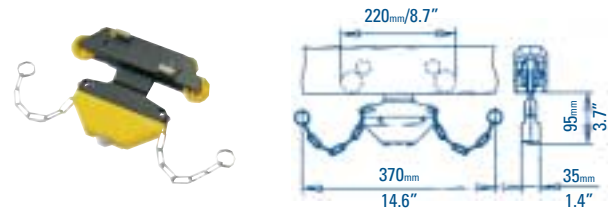

Double Collector - 80 Amp Rating

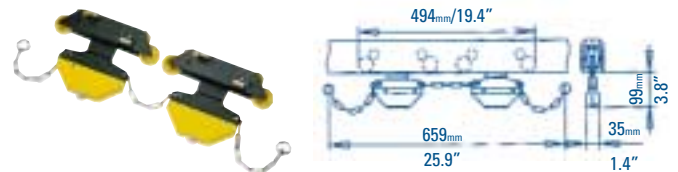

Triple Collector - 120 Amp Rating

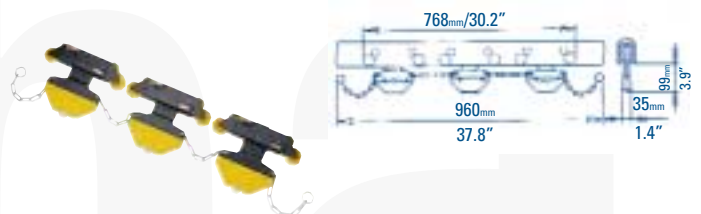

COLLECTORS ARE AVAILABLE WITH SPECIAL CABLE LENGTHS OR WITHOUT CABLE - PLEASE CONSULT FACTORY FOR MORE INFORMATION

6. Power Feed

130 and 200 Amp



PRE-FABRICATED POWER FEED IN A ONE METER LINE ELEMENT



| Part No. | Rating | Cable Diameter (in/mm) |
|----------|---------|------------------------|
| 5019 | 130 Amp | 0.41 / 10.5 |
| 5020 | 200 Amp | 0.57 / 14.4 |

Connecting cables are two (2) meters in length

Contact Electromotive Systems at 1-800-288-8178

8. Line Element Sliding Hanger

60, 100, 130 and 200 Amp



Prelacquered Steel
Premounted M8 X 60 Bolt

| Part No. | Weight lbs |
|----------|------------|
| 5027 | 0.2 |

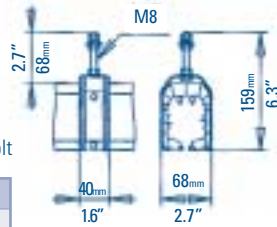

SNAPS ONTO LINE ELEMENTS
 ONE (1) - REQUIRED FOR 1 METER LINE ELEMENTS
 TWO (2) - REQUIRED FOR 2 METER LINE ELEMENTS
 TWO (2) - REQUIRED FOR 4 METER LINE ELEMENTS

9. Line Element Fixed Hanger

60, 100, 130 and 200 Amp



Prelacquered Steel
Premounted
M8 X 60 Bolt
Includes 4 anchoring
screws

| Part No. | Weight lbs |
|----------|------------|
| 5028 | 0.2 |

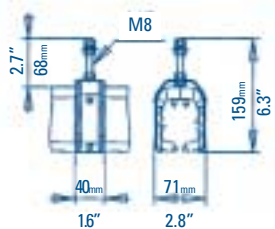

ANCHORS LINE ELEMENT TO STRUCTURE
 TWO (2) REQUIRED ON A SYSTEM WITHOUT AN EXPANSION
 FOUR (4) REQUIRED ON A SYSTEM WITH AN EXPANSION

10. End Cap

60, 100, 130 and 200 Amp



Thermoplastic
Self-extinguishing construction

| Part No. | Weight lbs |
|----------|------------|
| 5029 | 1.5 |

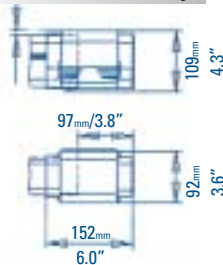

**SNAPS OVER END OF A LINE ELEMENT AND
INCLUDES END STOP TO PREVENT OVER TRAVEL OF COLLECTOR**

12. Tow Brackets

Single Collector Tow Bracket

For a single, 4 - Conductor, 40 Amp
Collector Assembly

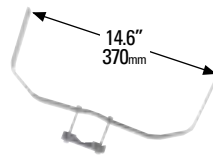

Double Collector Tow Bracket

For a Double, 4 - Conductor, 80 Amp
Collector Assembly

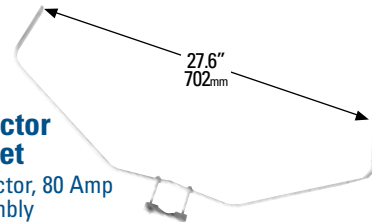

Triple Collector Tow Bracket

For a Triple, 4 - Conductor, 120 Amp
Collector Assembly

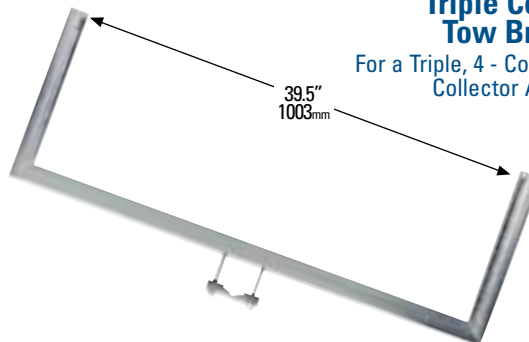

To be mounted onto a 0.79" [20mm] to 1.97" [50mm] round tow bar or a 0.79" [20mm] to 1.57" [40mm] square tow bar

| Part No. | Type | Weight lbs |
|----------|--------|------------|
| 5030 | Single | 1.3 |
| 5031 | Double | 2.4 |
| 5032 | Triple | 5.7 |

Junction boxes available for tow brackets - consult factory

11. Hanger Mounting Brackets

A

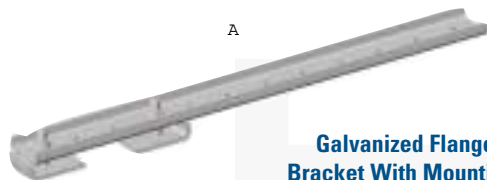

**Galvanized Flange Mounting
Bracket With Mounting Clamps**

| Part No. | Dimension A (in/mm) | Weights (lbs) |
|-----------|---------------------|---------------|
| BK-F18A-G | 18 / 457.2 | 2.2 |
| BK-F24A-G | 24 / 609.6 | 2.7 |

A



Galvanized Web Mounting Bracket

| Part No. | Dimension A (in/mm) | Weights (lbs) |
|----------|---------------------|---------------|
| BK-W15-G | 11.25 / 85.75 | 1.5 |
| BK-W18-G | 14.25 / 362 | 1.9 |
| BK-W24-G | 20.25 / 514.4 | 2.2 |

PRECISION SOLUTIONS FOR OVERHEAD MATERIAL HANDLING

Engineered Solutions & Automation

- Heavy Duty / Severe Duty Crane Control
- Automatic Crane & Monorail Process System Control
- Crane Positioning, Status & Diagnostics
- Collision Avoidance Control
- Crane Swing Control
- Crane Communication Control

IMPULSE® AC Adjustable Frequency Drives

- 230, 460, and 575 Volt Power Platforms - Up to 1,500 Hp
- Exclusive Application Software
- Specific Crane & Hoist Software

OmniPulse™ DC Digital Drives

- 30 to 500 HP
- 200 to 600 VDC

MAC™•2000 Motor Acceleration Control

- Single & 2 Speed

Variable Speed Motor Control Panels

- Standard Pre-Engineered Systems
- Custom Engineered Systems

Motors & Accessories

- Standard Inverter Duty AC Induction Motors
- Flux Vector Designed Motors

ELECTROBAR®, ELECTROBAR® FS, ELECTROBAR ELITE®, & FABA® Conductor Bar Systems

- Standard Duty
- Heavy Duty
- Mill Duty

ELECTROMOTIVE™ Festooning Systems

- Standard Duty
- Heavy Duty

SBP® & SBP2® Pendant Push Button Stations

- Standard 2 thru 12 Button Stations
- Custom Configured Stations

PulseStar® Radio Remote Controls

- PulseStar•MRT, PulseStar•jr, PulseStar•609, PulseStar•610

ReFlex®

- Collision Avoidance and Distance Detection Systems

SCS®

- Load Swing Control System



ELECTROMOTIVE SYSTEMS

a  **Magnetek Company**

P.O. Box 13615
Milwaukee WI, 53213

N49 W13650 Campbell Drive
Menomonee Falls, WI 53051

1-800-288-8178
Fax: 262-783-3510
<http://www.electromotive.com>